

BESPOKE CONCRETE

SPECIALISTS IN THE MANUFACTURE OF CUSTOM MADE PRE-CAST CONCRETE AND CAST STONE PRODUCTS

Bespoke Concrete Products Limited, Tynedale Works, Princess Way, Low Prudhoe, Northumberland NE42 6PL

t +44 (0) 1661 83 93 40 f +44 (0) 1661 83 39 23 e info@bespokeconcrete.co.uk w www.bespokeconcrete.co.uk

Case Study - North Staffs UHNS Trust PFI

In Early 2012 Bespoke Concrete were approached by Colour Urban Design to assist in the design and specification for the new North Staffs UHNS Trust PFI. The project required a variety of Bespoke Concrete elements with specific design, concrete chemistry and finish options.

The units for the project included:

- Planters at two main sizes and one custom sized to fit on site dimensions once others were fixed.
- Benches with custom designed cast in fittings and ductwork for LED lighting
- Curved and Straight Walls
- Kerbs
- Boot planter kerbs with and without custom light fitting points and drainage recesses.

Bespoke Concrete took the initial design concept and worked with it to optimise the design to achieve the highest quality units on time and on budget.



Bespoke Concrete Products Limited, VAT Number GB 605 5042 75, Registered in England number 2773783.
Registered address: Tynedale Works, Princess Way, Low Prudhoe, Northumberland NE42 6PL

Nitecrete Manufactured and developed by Bespoke Concrete Products Ltd. International Patent pending.



BESPOKE CONCRETE

SPECIALISTS IN THE MANUFACTURE OF CUSTOM MADE PRE-CAST CONCRETE AND CAST STONE PRODUCTS

Bespoke Concrete Products Limited, Tynedale Works, Princess Way, Low Prudhoe, Northumberland NE42 6PL
t +44 (0) 1661 83 93 40 f +44 (0) 1661 83 39 23 e info@bespokeconcrete.co.uk w www.bespokeconcrete.co.uk

Planter Units

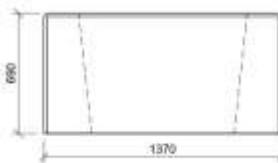
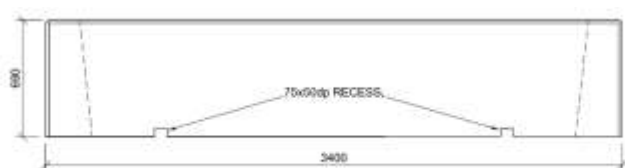

Bespoke Concrete Products Limited, VAT Number GB 605 5042 75, Registered in England number 2773783.
Registered address: Tynedale Works, Princess Way, Low Prudhoe, Northumberland NE42 6PL

Nitecrete Manufactured and developed by Bespoke Concrete Products Ltd. International Patent pending.



BESPOKE CONCRETE

SPECIALISTS IN THE MANUFACTURE OF CUSTOM MADE PRE-CAST CONCRETE AND CAST STONE PRODUCTS

Bespoke Concrete Products Limited, Tynedale Works, Princess Way, Low Prudhoe, Northumberland NE42 6PL
t +44 (0) 1661 83 93 40 f +44 (0) 1661 83 39 23 e info@bespokeconcrete.co.uk w www.bespokeconcrete.co.uk

Benches

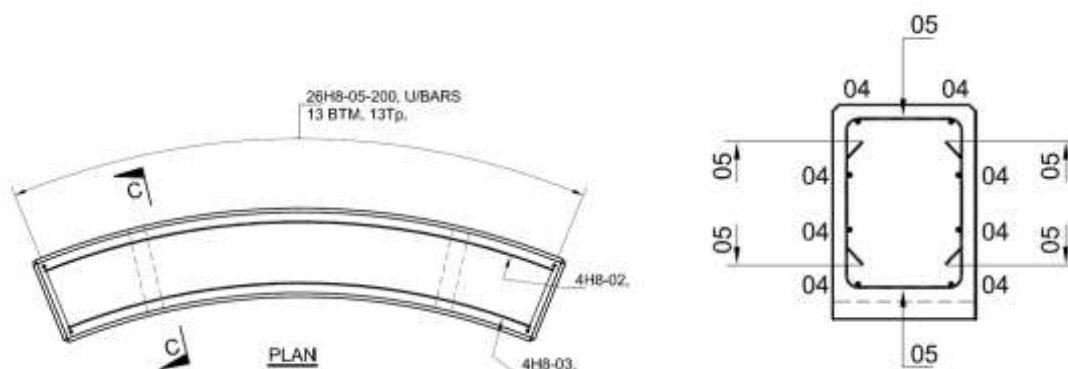

Bespoke Concrete Products Limited, VAT Number GB 605 5042 75, Registered in England number 2773783.
Registered address: Tynedale Works, Princess Way, Low Prudhoe, Northumberland NE42 6PL

Nitecrete Manufactured and developed by Bespoke Concrete Products Ltd. International Patent pending.



BESPOKE CONCRETE

SPECIALISTS IN THE MANUFACTURE OF CUSTOM MADE PRE-CAST CONCRETE AND CAST STONE PRODUCTS

Bespoke Concrete Products Limited, Tynedale Works, Princess Way, Low Prudhoe, Northumberland NE42 6PL
t +44 (0) 1661 83 93 40 f +44 (0) 1661 83 39 23 e info@bespokeconcrete.co.uk w www.bespokeconcrete.co.uk

Curved and Straight Walls

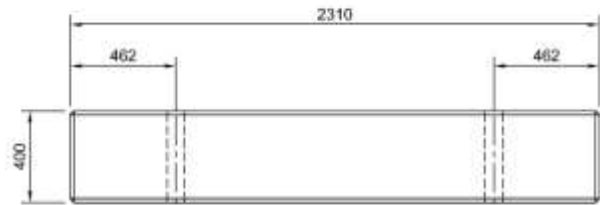
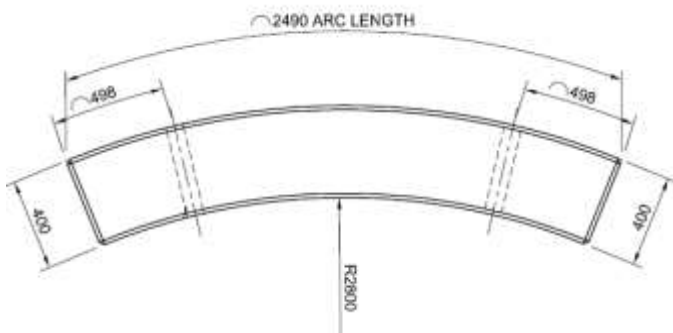
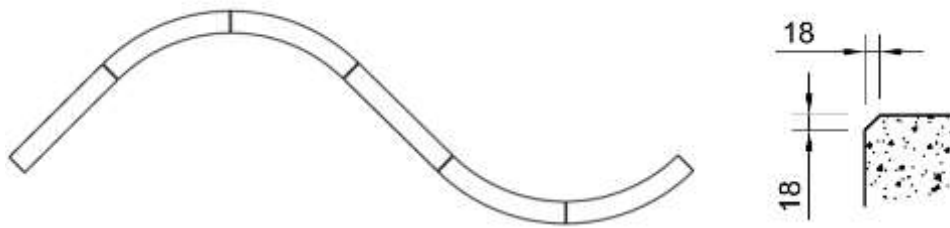

Bespoke Concrete Products Limited, VAT Number GB 605 5042 75, Registered in England number 2773783.
Registered address: Tynedale Works, Princess Way, Low Prudhoe, Northumberland NE42 6PL

Nitecrete Manufactured and developed by Bespoke Concrete Products Ltd. International Patent pending.



BESPOKE CONCRETE

SPECIALISTS IN THE MANUFACTURE OF CUSTOM MADE PRE-CAST CONCRETE AND CAST STONE PRODUCTS

Bespoke Concrete Products Limited, Tynedale Works, Princess Way, Low Prudhoe, Northumberland NE42 6PL
t +44 (0) 1661 83 93 40 f +44 (0) 1661 83 39 23 e info@bespokeconcrete.co.uk w www.bespokeconcrete.co.uk



Nitecrete

Northumberland MADE IN



Bespoke Concrete Products Limited, VAT Number GB 605 5042 75, Registered in England number 2773783.
Registered address: Tynedale Works, Princess Way, Low Prudhoe, Northumberland NE42 6PL

Nitecrete Manufactured and developed by Bespoke Concrete Products Ltd. International Patent pending.



BESPOKE CONCRETE

SPECIALISTS IN THE MANUFACTURE OF CUSTOM MADE PRE-CAST CONCRETE AND CAST STONE PRODUCTS

Bespoke Concrete Products Limited, Tynedale Works, Princess Way, Low Prudhoe, Northumberland NE42 6PL
t +44 (0) 1661 83 93 40 f +44 (0) 1661 83 39 23 e info@bespokeconcrete.co.uk w www.bespokeconcrete.co.uk

Boots and kerbs

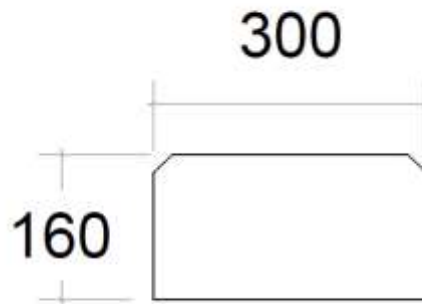
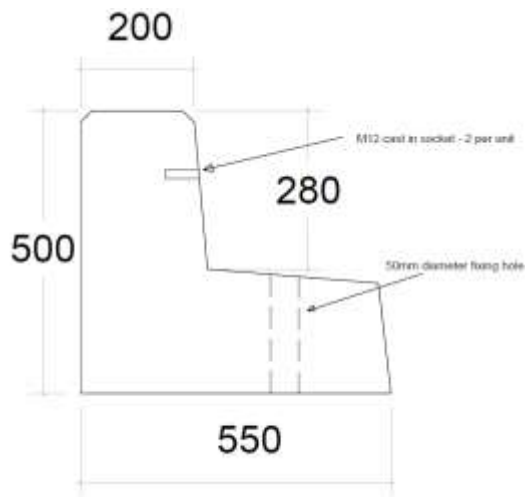

Nitecrete[™]

Northumberland MADE IN



INVESTORS IN PEOPLE



Bespoke Concrete Products Limited, VAT Number GB 605 5042 75, Registered in England number 2773783.
Registered address: Tynedale Works, Princess Way, Low Prudhoe, Northumberland NE42 6PL

Nitecrete Manufactured and developed by Bespoke Concrete Products Ltd. International Patent pending.

